

High Bay Ufo

80W LED High Bay Specification



Parameters

Product Model	HBUE-80W-120D-ONOFF
LED Chip Brand	Seoul
Light Efficiency	160lm/W (140 lm/W optional)
Luminous Flux	12800 lm
Color Temperature	5000K(3000K, 4000K optional)
Beam Angle	90° (60°, 120° optional)
Total Power Consumption	80W±3W
Output Current	0.62A(constant current)
Output Voltage	DC 116 ~ 124V
Net Weight	2.4±0.2kg
Light Dimensions	L240mm×W240mm×H176mm
Light Package Dimensions	L280mm×W280mm×H220mm

Light Distribution

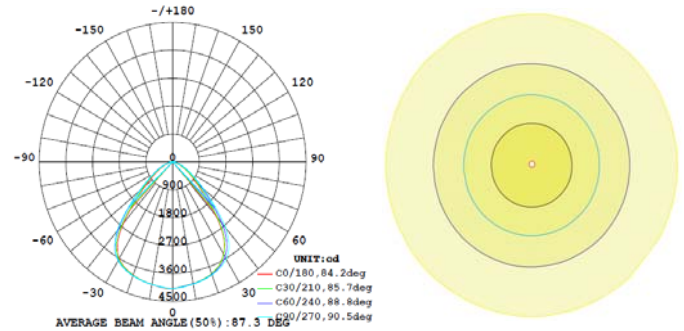

Physical Dimensions

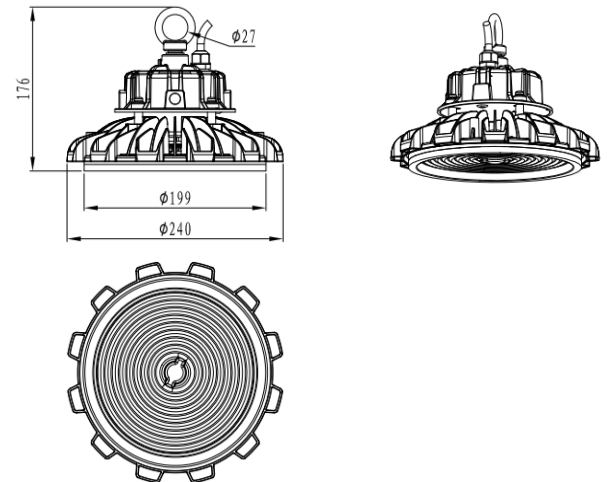

≥0.95	70 Ra	IP65	≥100000 Hrs	AC 100-277V	47-63Hz
Power Factor	CRI	IP Level	TM-21(L ₇₀)	Input Voltage	Power Frequency

Others

Power Efficiency	Working Temperature (Environment)	Heat Sink Surface Temperature
≥92%	-40°C ~ +50°C	63.2°C (Room Temperature 30°C)
Fixture Efficiency	Working Humidity (Environment)	Luminaire Base Temperature
≥90%	15% ~ 90%RH	76.4°C (Room Temperature 30°C)
Total Harmonic Distortion	Storing Condition	LED Power Consumption
≤15%	-40°C ~ +65°C	74W±3W

Suitable for Factory, Warehouse, Gymnasium, Gas station, Shopping mall, Garage and other Lighting Purposes